

EURAC®

COURBES ET RACCORDS À COMPRESSION BENDS & COMPRESSION COUPLINGS

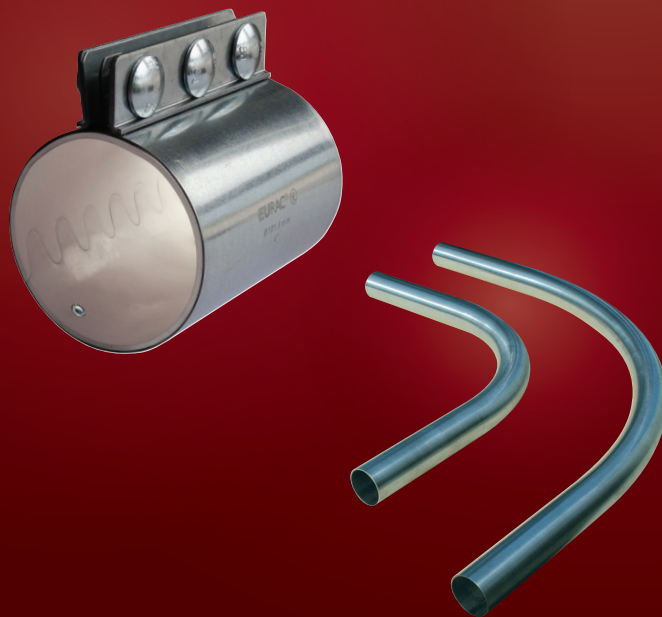

STIF

components for your success

► Français

► English



Fondée en 1984, la société S.T.I.F. s'est créée une solide réputation internationale en exportant dans plus de 60 pays. Implantée dans l'ouest de la France près d'ANGERS à 80 km du port de NANTES-ST NAZAIRE, l'unité de production s'étend sur 10 000 m².

La société STIF a conçu sa gamme de raccords à compression en 1989. Ce système rapide d'installation, qui remplace parfaitement les brides, est la solution adéquate pour assembler vos réseaux de tuyauterie en dépoussiérage industriel ou en transport pneumatique. Pouvant résister jusqu'à 25 bar de pression, la gamme de raccords EURAC fonctionne aussi bien en phase diluée qu'en phase dense, en aspiration ou en refoulement.

Established 1984, the S.T.I.F. Company has earned a solid international reputation by exporting to more than 60 countries. The production unit is based in the west of France near ANGERS, 80 km from the NANTES-ST NAZAIRE harbour, and extends over 10 000 m².

The company STIF, manufacturer of components for the bulk handling of products, designed their range of compression couplings since 1989. This quick installation system which perfectly replaces flanges is the adequate solution to put together your pipes network of industrial dusting or pneumatic transport. Able to withstand a pressure up to 25 bar the range of EURAC couplings works as well in diluted or dense phases, in aspiration or reversing installations.



RACCORDS POUR TRANSPORT PNEUMATIQUE COUPLINGS FOR PNEUMATIC CONVEYING TUBES

L



Transport pneumatique phase diluée en aspiration ou refoulement produits légers.
Pneumatic conveying (diluted concentration light particles) vacuum or pressure systems.

L100
Ø 38,1 Δ 114,3

p. 4-5

M



Transport pneumatique phase diluée en aspiration ou refoulement produits légers.
Pneumatic conveying (diluted concentration light particles) vacuum or pressure systems.

L150
Ø 38,1 Δ 114,3

p. 6-7

HL



Transport pneumatique phase diluée ou phase dense.
Pneumatic conveying (diluted and heavy concentration light particles) vacuum or pressure systems.

L100 - L150 - L200
Ø 38,1 Δ 168,3

p. 8-9

H



Transport pneumatique phase diluée ou phase dense.
Pneumatic conveying (diluted and heavy concentration light particles) vacuum or pressure systems.

L150 - L200
Ø 38,1 Δ 219,1

p. 10-11

HX



Transport pneumatique phase diluée ou phase dense.
Pneumatic conveying (diluted and heavy concentration light particles) vacuum or pressure systems.

L200 - L250 - L300
Ø 200 Δ 355,6

p. 12

Bends

COURBES À GRAND RAYON - PIÈCES DE LIAISON PIPE BENDS - CONNECTORS



p. 13-14-15

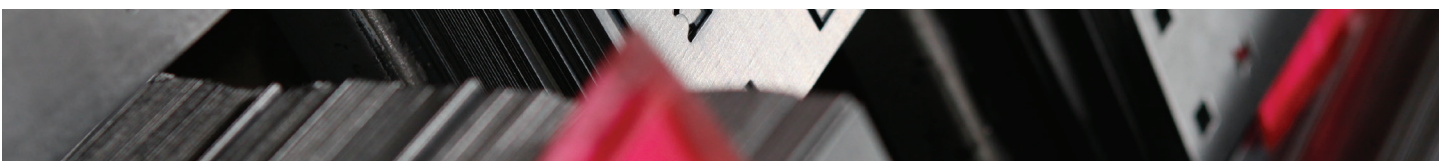

TRANSPORT PNEUMATIQUE PHASE DILUÉE EN ASPIRATION OU REFOULEMENT PRODUITS LÉGERS

PNEUMATIC CONVEYING (DILUTED CONCENTRATION LIGHT PARTICLES)
VACUUM OR PRESSURE SYSTEMS



L	100 mm
∅	38.1 <> 114.3 mm
Boulons Bolts	M8
Serrage Tightening	16 N.m

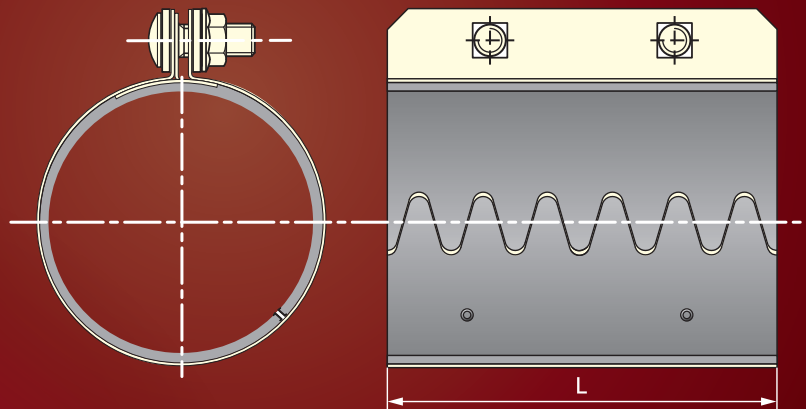

DESCRIPTIF STANDARD

- Enveloppe extérieure inox 430
- Joint SBR noir -30°C/+80°C
- Boulons zingués
- Conductivité avec œillet

SPECIFICATION OF STANDARD COUPLING

- Outside skin in stainless steel 430
- Black SBR gasket -30°C/+80°C
- Zinc plated bolts
- Conductivity with eyelet

OPTIONS

- Version tout inox 304L
- Joint NBR blanc FDA -30°C/+110°C;
Règlement Européen 1935/2004 CE et REACH 1907/2006 CE
- Joint silicone VMQ -65°C/+225°C;
Règlement Européen 1935/2004 CE et REACH 1907/2006 CE
- Joint silicone détectable bleu -40°C/+180°C;
Règlement Européen 1935/2004 CE et REACH 1907/2006 CE
- Joint Viton FKM noir -20°C/+250°C
- Raccord pont (voir p. 5)
- Raccord pour 2 diamètres différents (voir p. 5)
- Lamelle de conductivité cuivre CU A1
- Anneau protecteur conductif inox 304L (voir p. 5)

OPTIONS

- All stainless steel 304L version
- White NBR gasket FDA -30°C/+110°C;
European Regulation 1935/2004 EC and REACH 1907/2006 EC
- Silicone VMQ gasket -65°C/+225°C;
European Regulation 1935/2004 EC and REACH 1907/2006 EC
- Blue silicone gasket -40°C/+180°C;
European Regulation 1935/2004 EC and REACH 1907/2006 EC
- Viton FKM gasket -20°C/+250°C
- Coupling with clamp and side bars (see p. 5)
- Coupling for two tubes with different diameters (see p. 5)
- Conductivity strip in copper CU A1
- Conductive protecting ring in stainless steel 304L (see p. 5)

- Référence réglementaire - Reference to regulation: **N°97/23/CE.G2 Art.3 §3**
- Exemple de marquage du produit - Example of product marking: **EURAC® L D 54**

COURBES PRESSION MAXIMUM EURAC L: L 100
 MAXIMUM PRESSURE CURVES FOR EURAC L: L100

Pression maximum de service tuyauterie libre
 Maximum working pressure with free-hanging pipes

Pression maximum de service tuyauterie bloquée
 Maximum working pressure with clamped pipes

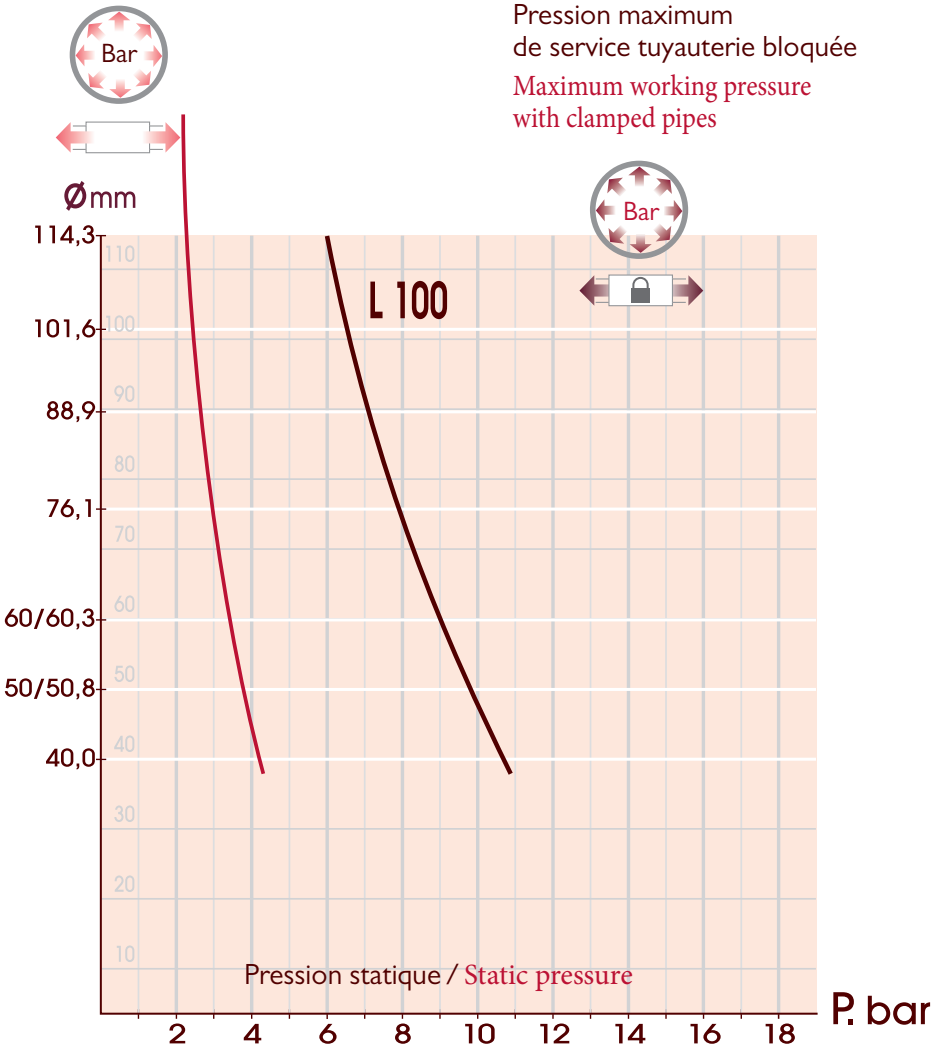

Ø	L100
38,1	En stock - On stock
40	En stock - On stock
45	En stock - On stock
50/50,8	En stock - On stock
54	En stock - On stock
55	En stock - On stock
60/60,3	En stock - On stock
63,5	En stock - On stock
65	En stock - On stock
70	En stock - On stock
75	En stock - On stock
76,1	En stock - On stock
80	En stock - On stock
82	En stock - On stock
84	En stock - On stock
85	En stock - On stock
88,9	En stock - On stock
95	En stock - On stock
100	En stock - On stock
101,6	En stock - On stock
104	En stock - On stock
105	En stock - On stock
108	En stock - On stock
114,3	En stock - On stock

En stock - On stock
 Sur commande - On order

OPTIONS - OPTIONS

- Raccord pont
Coupling with clamp and side bars

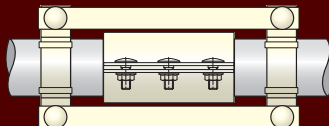

- Anneau protecteur conducteur inox 304L
Conductive protection ring in stainless steel 304L



- Raccord pour 2 diamètres différents
Coupling for two tubes with different diameters

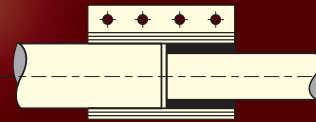

TRANSPORT PNEUMATIQUE PHASE DILUÉE EN ASPIRATION OU REFOULEMENT PRODUITS LÉGERS

PNEUMATIC CONVEYING (DILUTED CONCENTRATION LIGHT PARTICLES)
VACUUM OR PRESSURE SYSTEMS



L	150 mm
∅	38.1 <> 114.3 mm
Boulons Bolts	M8
Serrage Tightening	16 N.m

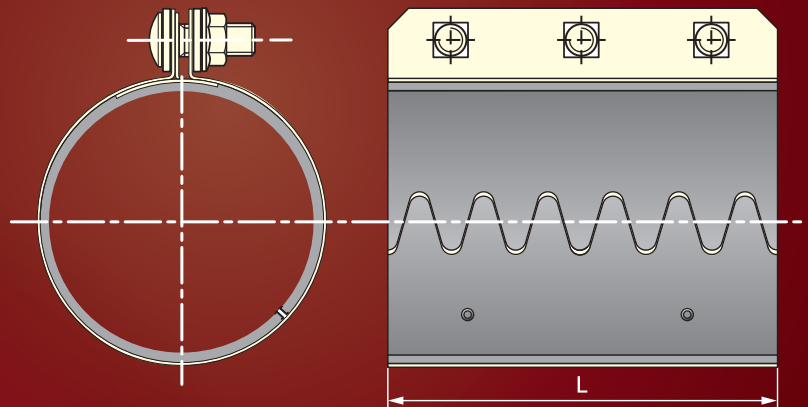

DESCRIPTIF STANDARD

- Enveloppe extérieure inox 430
- Joint SBR noir -30°C/+80°C
- Boulons zingués
- Conductivité avec œillet

SPECIFICATION OF STANDARD COUPLING

- Outside skin in stainless steel 430
- Black SBR gasket -30°C/+80°C
- Zinc plated bolts
- Conductivity with eyelet

OPTIONS

- Version tout inox 304L
- Joint NBR blanc FDA -30°C/+110°C;
Règlement Européen 1935/2004 CE et REACH 1907/2006 CE
- Joint silicone VMQ -65°C/+225°C;
Règlement Européen 1935/2004 CE et REACH 1907/2006 CE
- Joint silicone détectable bleu -40°C/+180°C;
Règlement Européen 1935/2004 CE et REACH 1907/2006 CE
- Joint Viton FKM noir -20°C/+250°C
- Raccord pont (voir p. 7)
- Raccord pour diamètres différents (voir p. 7)
- Lamelle de conductivité cuivre CU A1
- Anneau protecteur conductif inox 304L (voir p. 7)

OPTIONS

- All stainless steel 304L version
- White NBR gasket FDA -30°C/+110°C;
European Regulation 1935/2004 EC and REACH 1907/2006 EC
- Silicone VMQ gasket -65°C/+225°C;
European Regulation 1935/2004 EC and REACH 1907/2006 EC
- Blue silicone gasket -40°C/+180°C;
European Regulation 1935/2004 EC and REACH 1907/2006 EC
- Viton FKM gasket -20°C/+250°C
- Coupling with clamp and side bars (see p. 7)
- Coupling for tubes with different diameters (see p. 7)
- Conductivity strip in copper CU A1
- Conductive protecting ring in stainless steel 304L (see p. 7)

- Référence réglementaire - Reference to regulation: **N°97/23/CE.G2 Art.3 §3**
- Exemple de marquage du produit - Example of product marking: **EURAC® M D 63.5**

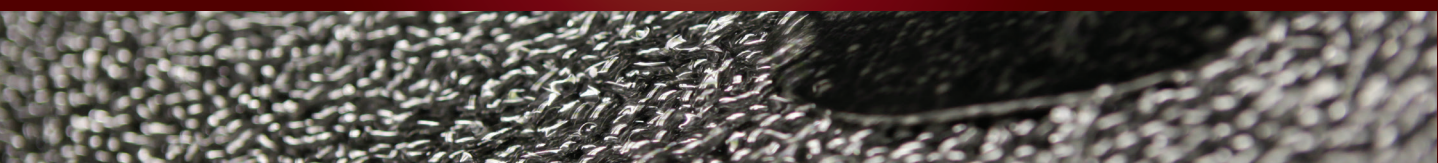

COURBES PRESSION MAXIMUM EURAC M: L 150
 MAXIMUM PRESSURE CURVES FOR EURAC M: L 150



Pression maximum de service tuyauterie libre
 Maximum working pressure with free-hanging pipes

Pression maximum de service tuyauterie bloquée
 Maximum working pressure with clamped pipes

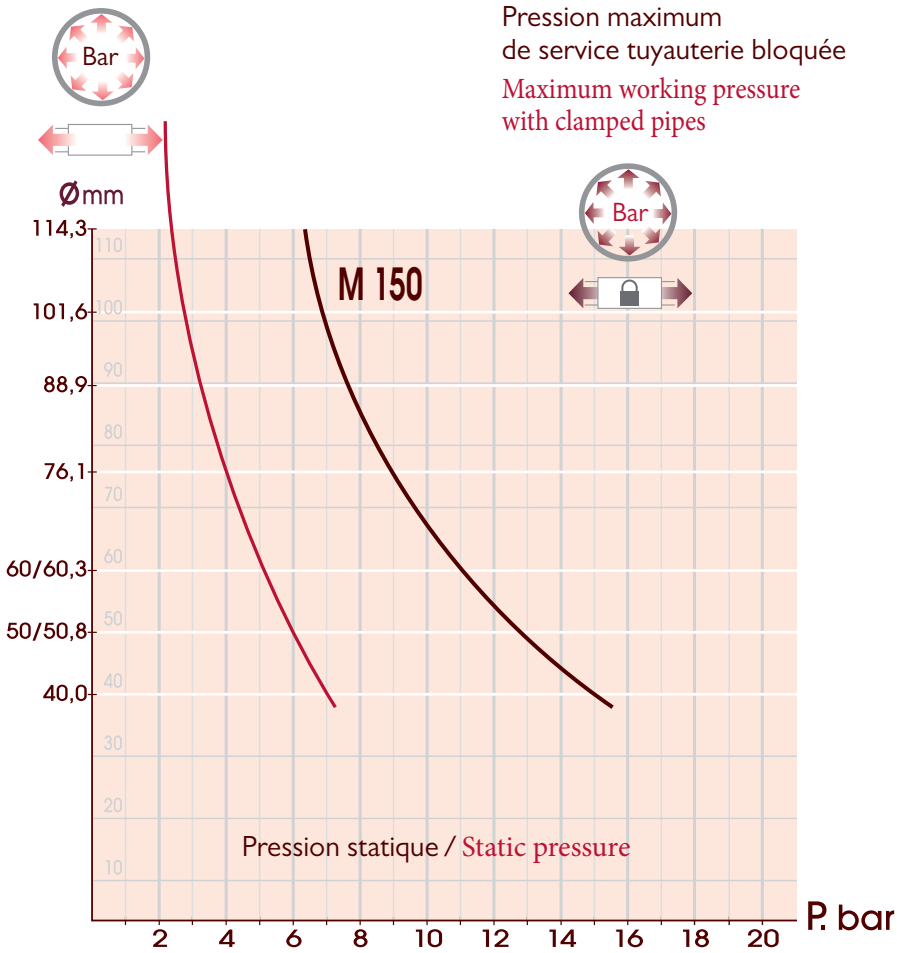

Ø	L150
38,1	
40	
45	
50/50,8	
54	
55	
60/60,3	
63,5	
65	
70	
75	
76,1	
80	
82	
84	
85	
88,9	
95	
100	
101,6	
104	
105	
108	
114,3	

En stock - On stock
 Sur commande - On order

OPTIONS - OPTIONS

- Raccord pont
Coupling with clamp and side bars

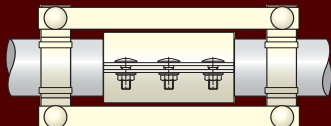

- Anneau protecteur conducteur inox 304L
Conductive protection ring in stainless steel 304L



- Raccord pour 2 diamètres différents
Coupling for two tubes with different diameters

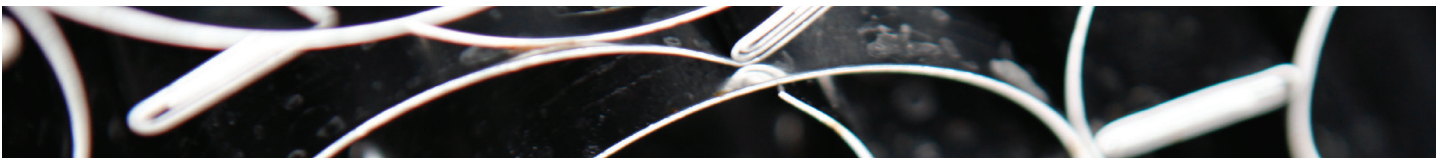
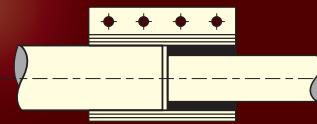

NEW

EURAC® HL

TRANSPORT PNEUMATIQUE PHASE DILUÉE OU PHASE DENSE PNEUMATIC CONVEYING (DILUTED AND HEAVY CONCENTRATION LIGHT PARTICLES) VACUUM OR PRESSURE SYSTEMS

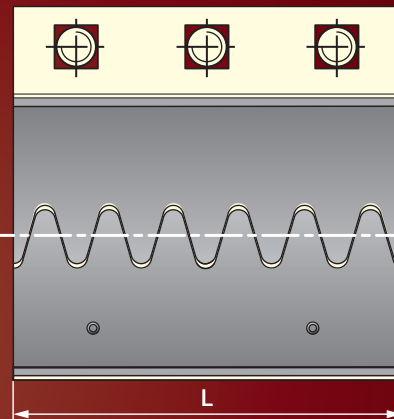
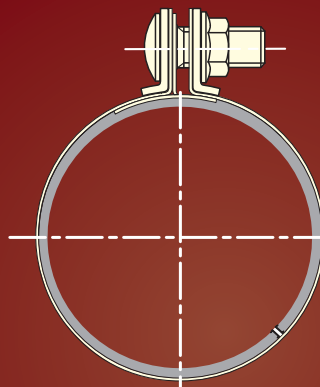

L	100 mm
∅	38.1 ≤ ∅ ≤ 114,3 mm
Boulons Bolts	M12
Serrage Tightening	M12: 60 N.m

L	150-200 mm
∅	38.1 ≤ ∅ ≤ 168,3 mm
Boulons Bolts	M12
Serrage Tightening	M12: 60 N.m

DESCRIPTIF STANDARD

- Enveloppe extérieure acier galvanisé
- Couver joint acier galvanisé
- Joint NBR blanc FDA -30°C/+110°C;
Règlement Européen 1935/2004 CE et REACH 1907/2006 CE
- Boulons zingués
- Conductivité avec œillet

OPTIONS

- Version tout inox 304L
- Joint SBR noir -30°C/+80°C
- Joint silicone VMQ -65°C/+225°C;
Règlement Européen 1935/2004 CE et REACH 1907/2006 CE
- Joint silicone détectable bleu -40°C/+180°C;
Règlement Européen 1935/2004 CE et REACH 1907/2006 CE
- Joint Viton FKM noir -20°C/+250°C
- Raccord pont (voir p. 9)
- Raccord pour diamètres différents
- Lamelle de conductivité cuivre CU A1
- Anneau protecteur conducteur inox 304L (voir p. 9)

SPECIFICATION OF STANDARD COUPLING

- Outside skin in galvanised steel
- Gasket cover in galvanised steel
- White NBR gasket FDA -30°C/+110°C;
European Regulation 1935/2004 EC and REACH 1907/2006 EC
- Zinc plated bolts
- Conductivity with eyelet

OPTIONS

- All stainless steel 304L version
- Black SBR gasket -30°C/+80°C
- Silicone VMQ gasket -65°C/+225°C;
European Regulation 1935/2004 EC and REACH 1907/2006 EC
- Blue gasket silicone -40°C/+180°C;
European Regulation 1935/2004 EC and REACH 1907/2006 EC
- Viton FKM gasket -20°C/+250°C
- Coupling with clamp and side bars (see p. 9)
- Coupling for different diameters
- Conductivity strip in copper CU A1
- Conductive protection ring in stainless steel 304L (see p. 9)

- Référence réglementaire - Reference to regulation: **N°97/23/CE.G2 Art.3 §3**
- Exemple de marquage du produit - Example of product marking: **EURAC® HL D 88.9**

COURBES PRESSION MAXIMUM EURAC HL: L 100, L 150 ET L 200

MAXIMUM PRESSURE CURVES FOR EURAC HL:

L100, L150 AND L200

Pression maximum de service tuyauterie libre
Maximum working pressure with free-hanging pipes



Pression maximum de service tuyauterie bloquée
Maximum working pressure with clamped pipes

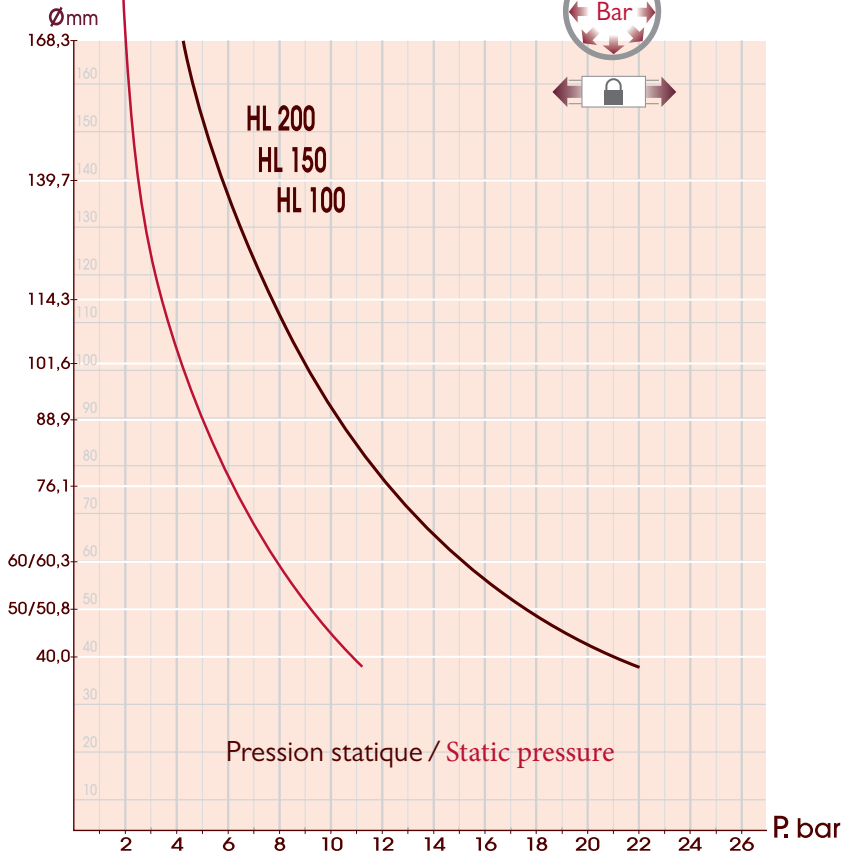

Ø	L100	L150	L200
38,1			
40			
45			
48,3			
50/50,8			
54			
55			
60/60,3			
63,5			
65			
70			
75			
76,1			
80			
82			
84			
85			
88,9			
90			
95			
100			
101,6			
104			
105			
108			
114,3			
125			
127			
129			
133			
139,7			
145			
152,4			
154			
155			
159			
168,3			

OPTIONS - OPTIONS

- Raccord pont
Coupling with clamp and side bars

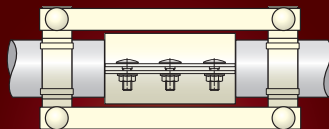

- Anneau protecteur conducteur inox 304L
Conductive protection ring in stainless steel 304L



- Raccord pour 2 diamètres différents
Coupling for two tubes with different diameters

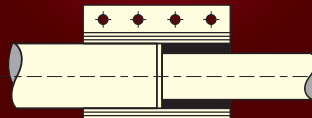

En stock - On stock
 Sur commande - On order
 Non disponible - Not available

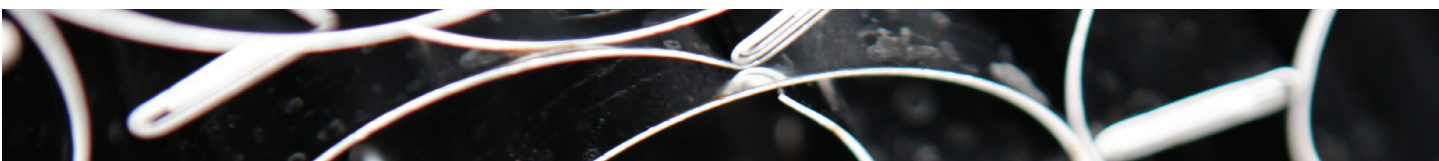

TRANSPORT PNEUMATIQUE PHASE DILUÉE OU PHASE DENSE

PNEUMATIC CONVEYING (DILUTED AND HEAVY CONCENTRATION LIGHT PARTICLES) VACUUM OR PRESSURE SYSTEMS



L	150-200 mm
∅	38,1 <> 219,1 mm
Boulons Bolts	M12 < ∅ 88,9 M16 ≥ ∅ 88,9
Serrage Tightening	M12: 60N.m M16: 120N.m

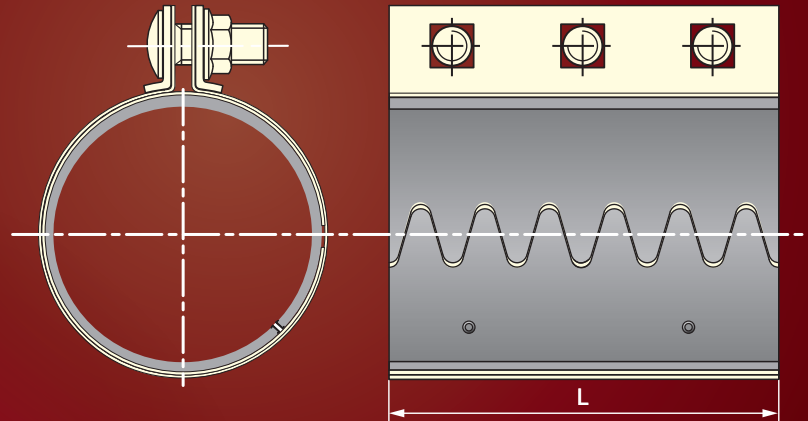

DESCRIPTIF STANDARD

- Enveloppe extérieure acier galvanisé
- Enveloppe intérieure acier galvanisé
- Joint NBR blanc FDA -30°C/+110°C;
Règlement Européen 1935/2004 CE et REACH 1907/2006 CE
- Boulons zingués
- Conductivité avec œillet

SPECIFICATION OF STANDARD COUPLING

- Outside skin in galvanised steel
- Inside skin in galvanised steel
- White NBR gasket FDA -30°C/+110°C;
European Regulation 1935/2004 EC and REACH 1907/2006 EC
- Zinc plated bolts
- Conductivity with eyelet

OPTIONS

- Version tout inox 304L
- Joint SBR noir -30°C/+80°C
- Joint silicone VMQ -65°C/+225°C;
Règlement Européen 1935/2004 CE et REACH 1907/2006 CE
- Joint silicone détectable bleu -40°C/+180°C;
Règlement Européen 1935/2004 CE et REACH 1907/2006 CE
- Joint Viton FKM noir -20°C/+250°C
- Raccord pont (voir p. 11)
- Raccord pour diamètres différents (voir p. 11)
- Lamelle de conductivité cuivre CU A1
- Anneau protecteur conducteur inox 304L (voir p. 11)

OPTIONS

- All stainless steel 304L version
- Black rubber SBR gasket -30°C/+80°C
- Silicone VMQ gasket -65°C/+225°C;
European Regulation 1935/2004 EC and REACH 1907/2006 EC
- Blue silicone gasket -40°C/+180°C;
European Regulation 1935/2004 EC and REACH 1907/2006 EC
- Viton FKM gasket -20°C/+250°C
- Coupling with clamp and side bars (see p. 11)
- Coupling for tubes with different diameters (see p. 11)
- Conductivity strip in copper CU A1
- Conductive protection ring in stainless steel 304L (see p. 11)

- Référence réglementaire - Reference to regulation: **N°97/23/CE.G2 Art.3 §3**
- Exemple de marquage du produit - Example of product marking: **EURAC® H D 88.9**

COURBES PRESSION MAXIMUM EURAC H: L 150 ET L 200
 MAXIMUM PRESSURE CURVES FOR EURAC H: L 150 AND L 200

Pression maximum de service tuyauterie libre
 Maximum working pressure with free-hanging pipes



Pression maximum de service tuyauterie bloquée
 Maximum working pressure with clamped pipes

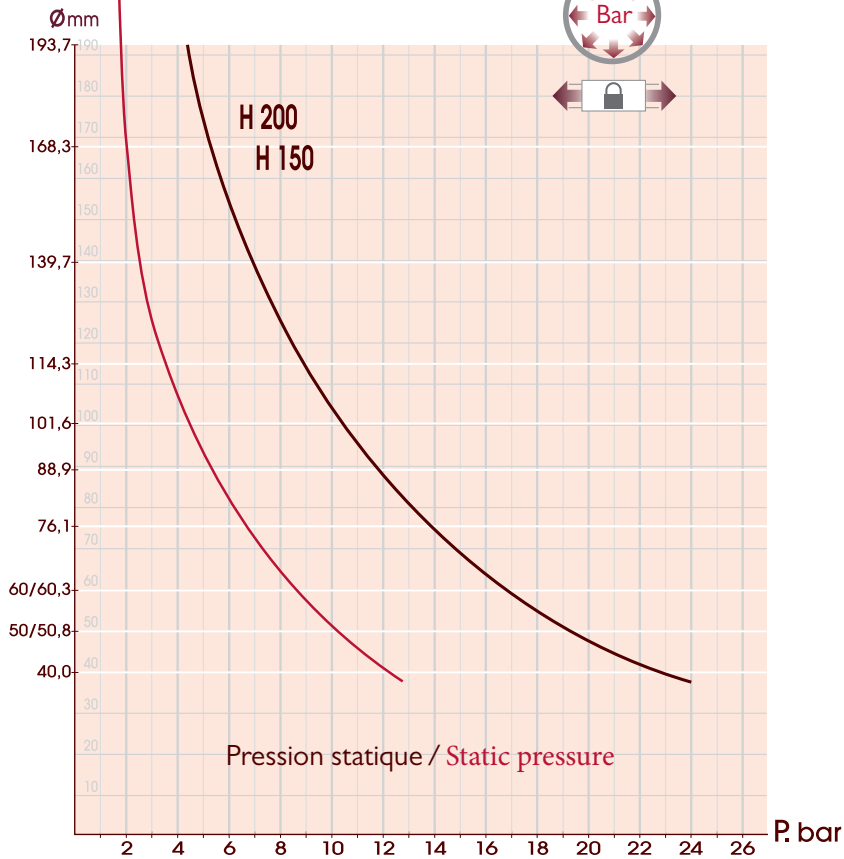

Ø	L150	L200
38,1		
40		
45		
48,3		
50/50,8		
54		
55		
60/60,3		
63,5		
65		
70		
75		
76,1		
80		
82		
84		
85		
88,9		
90		
95		
100		
101,6		
104		
105		
108		
114,3		
125		
127		
129		
133		
139,7		
145		
152,4		
154		
155		
159		
168,3		
219,1		

OPTIONS - OPTIONS

• Raccord pont
 Coupling with clamp and side bars

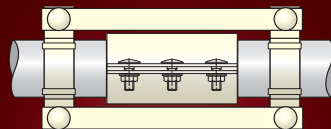

• Anneau protecteur conducteur inox 304L
 Conductive protection ring in stainless steel 304L



• Raccord pour 2 diamètres différents
 Coupling for two tubes with different diameters

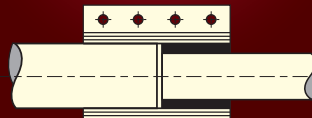

En stock - On stock
 Sur commande - On order

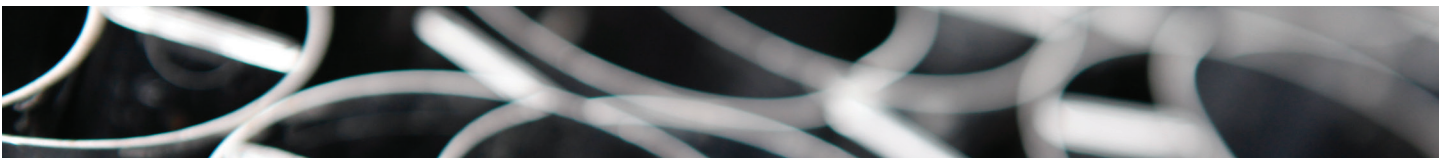

TRANSPORT PNEUMATIQUE PHASE DILUÉE OU PHASE DENSE

PNEUMATIC CONVEYING (DILUTED AND HEAVY CONCENTRATION LIGHT PARTICLES) VACUUM OR PRESSURE SYSTEMS

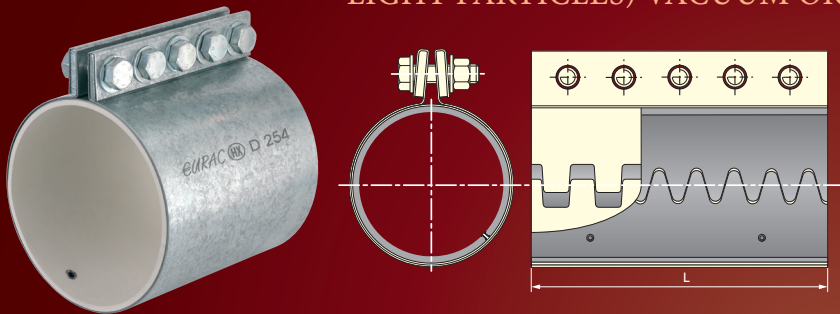

L	200 - 250 - 300 mm
∅	200 <-> 355,6 mm
Boulons Bolts	M20
Serrage Tightening	200 N.m

Pression maximum de service tuyauterie libre
Maximum working pressure with free-hanging pipes

Pression maximum de service tuyauterie bloquée
Maximum working pressure with clamped pipes

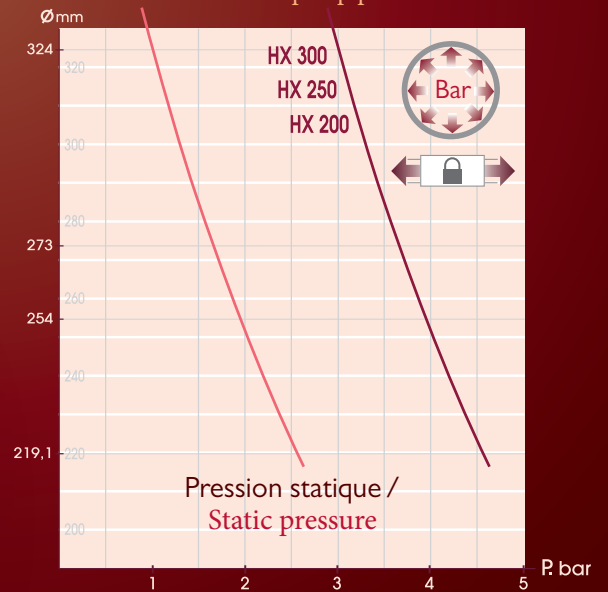

DESCRIPTIF STANDARD / SPECIFICATION OF STANDARD COUPLING

- Enveloppe extérieure acier galvanisé
Outside skin in galvanised steel
- Enveloppe intérieure acier galvanisé
Inside skin in galvanised steel
- Joint NBR blanc FDA -30°C/+110°C;
Règlement Européen 1935/2004 CE et REACH 1907/2006 CE
White NBR gasket FDA -30°C/+110°C;
European Regulation 1935/2004 EC and REACH 1907/2006 EC
- Boulons zingués
Zinc plated bolts
- Lamelle de conductivité inox 304 L
Stainless steel 304 L, conductivity strip

OPTIONS / OPTIONS

- Version tout inox 304L / All stainless steel 304L version
- Joint SBR noir -30°C/+80°C / Black SBR gasket -30°C/+80°C
- Joint silicone VMQ / Silicone VMQ gasket -65°C/+225°C;
Règlement Européen 1935/2004 CE et REACH 1907/2006 CE
European Regulation 1935/2004 EC and REACH 1907/2006 EC
- Joint silicone détectable bleu -40°C/+180°C;
Règlement Européen 1935/2004 CE et REACH 1907/2006 CE
Blue silicone gasket -40°C/+180°C;
European Regulation 1935/2004 EC and REACH 1907/2006 EC
- Joint Viton FKM noir -20°C/+250°C
Viton FKM gasket -20°C/+250°C
- Raccord pont / Coupling with clamp and side bars
- Lamelle de conductivité cuivre CU A1
Conductivity strip in copper CU A1
- Anneau protecteur conductif inox 304L
Conductive protection ring in stainless steel 304L

 En stock
On stock

 Sur commande
On order

∅	L200	L250	L300
200			
203,2			
219,1			
244,5			
254			
273			
323,9			
355,6			

• Référence réglementaire - Reference to regulation:
N°97/23/CE.G2 Art.3 §3

• Exemple de marquage du produit - Example of product marking:
EURAC® HX D 254

OPTIONS - OPTIONS

- Raccord pont
Coupling with clamp and side bars

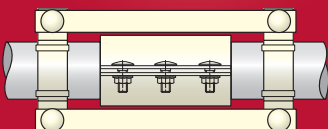

- Anneau protecteur conductif inox 304L
Conductive protection ring in stainless steel 304L



- Raccord pour 2 diamètres différents
Coupling for two tubes with different diameters

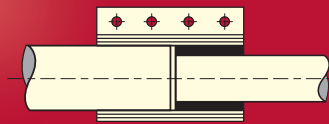

Bends

COURBES À GRAND RAYON - INOX 304 PIPE BENDS - STAINLESS STEEL 304

INTÉRIEUR / INSIDE:
Rugosité / Roughness = Ra: 0.8 µm
EXTÉRIEUR / OUTSIDE:
Polissage ultra son / Ultrasound Polishing:
Grain 220

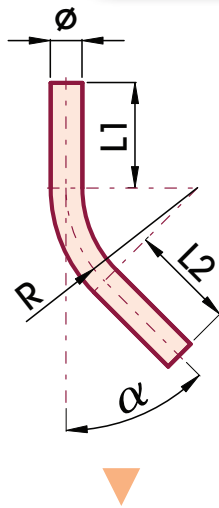
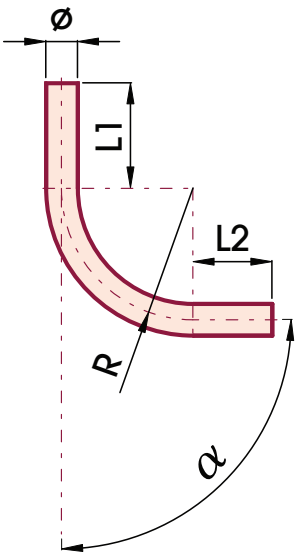

02 BCBI

Tube Pipe	R	90		150		250		300		380		500		800		1000		
	α	45°	90°	45°	90°	45°	90°	45°	90°	45°	90°	45°	90°	45°	90°	45°	90°	
	L1 = L2	100	200	100	185	200	100	200	100	200	100	200	100	200	100	200	100	200
ø 38,1x1,5																		
ø 40x1,5																		
ø 45x1,5																		
ø 50x1,5																		
ø 50x2																		
ø 60,3x1,5																		
ø 63,5x1,5																		
ø 65x1,5																		
ø 70x2																		
ø 76,1x2																		
ø 80x2																		
ø 84x2																		
ø 88,9x2																		
ø 101,6x2																		
ø 104x2																		
ø 108x2																		
ø 114,3x2																		

Disponible - Available



PIÈCES DE LIAISON - INOX 304

CONNECTORS - STAINLESS STEEL 304

02 BYAI - 30°

Tube / Pipe ø1 / ø2		α		30°											
		L		L1					L2						
		250	300	370	400	450	160	200	250	300	350				
ø1 38,1x1,5	ø2 38,1x1,5														
ø1 40x1,5	ø2 40x1,5														
ø1 45x1,5	ø2 45x1,5														
ø1 50x1,5	ø2 50x1,5														
ø1 60,3x1,5	ø2 45x1,5														
ø1 60,3x1,5	ø2 60,3x1,5														
ø1 65x1,5	ø2 65x1,5														
ø1 70x2	ø2 50x2														
ø1 70x2	ø2 70x2														
ø1 76,1x2	ø2 76,1x2														
ø1 80x2	ø2 80x2														
ø1 84x2	ø2 84x2														
ø1 88,9x2	ø2 88,9x2														
ø1 101,6x2	ø2 101,6x2														
ø1 108x2	ø2 108x2														
ø1 114,3x2	ø2 114,3x2														

INTÉRIEUR / INSIDE:
Rugosité/Roughness = Ra : 0.8 µm
EXTÉRIEUR / OUTSIDE:
Polissage ultra son / Ultrasound Polishing :
Grain 220

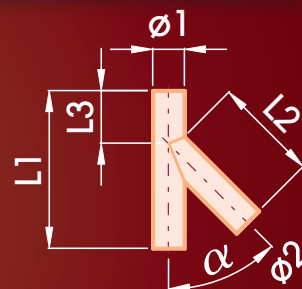

$$L3 = L1 - L2$$

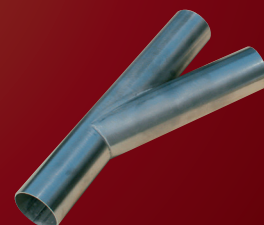

02 BYAI - 45°

Tube / Pipe ø1 / ø2		α		45°											
		L		L1					L2						
		250	300	370	400	450	160	200	250	300	350				
ø1 38,1x1,5	ø2 38,1x1,5														
ø1 40x1,5	ø2 40x1,5														
ø1 45x1,5	ø2 45x1,5														
ø1 50x1,5	ø2 50x1,5														
ø1 60,3x1,5	ø2 45x1,5														
ø1 60,3x1,5	ø2 60,3x1,5														
ø1 65x1,5	ø2 65x1,5														
ø1 70x2	ø2 70x2														
ø1 76,1x2	ø2 50x1,5														
ø1 76,1x2	ø2 60,3x1,5														
ø1 76,1x2	ø2 76,1x2														
ø1 80x2	ø2 80x2														
ø1 84x2	ø2 84x2														
ø1 88,9x2	ø2 88,9x2														
ø1 100x2	ø2 100x2														
ø1 101,6x2	ø2 101,6x2														
ø1 104x2	ø2 104x2														
ø1 108x2	ø2 108x2														
ø1 114,3x2	ø2 114,3x2														

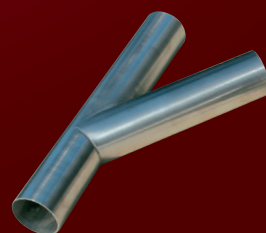

02 BYAI - 60°

Tube / Pipe ø1 / ø2		α		45°											
		L		L1					L2						
		250	300	370	400	450	160	200	250	300	350				
ø1 50,1x1,5	ø2 50x1,5														
ø1 65x1,5	ø2 65x1,5														

Disponible - Available

Bends

PIÈCES DE LIAISON - INOX 304 CONNECTORS - STAINLESS STEEL 304

INTÉRIEUR / INSIDE:
Rugosité/Roughness = Ra: 0.8 µm
EXTÉRIEUR / OUTSIDE:
Polissage ultra son/Ultrasonic Polishing:
Grain 220

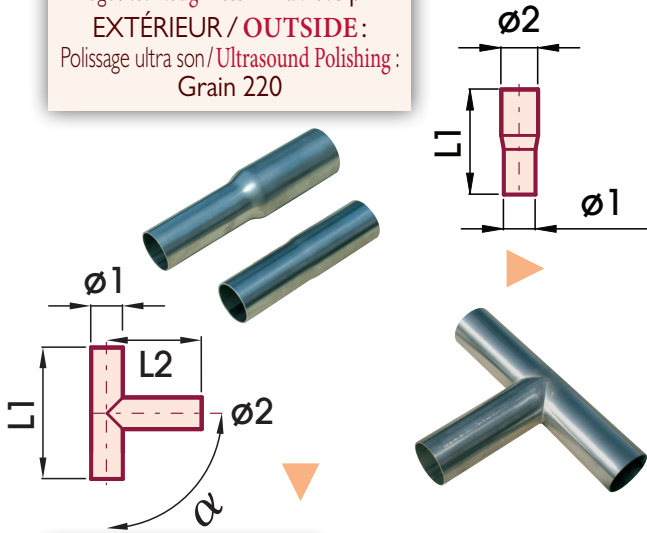

02 BTEI

Tube/Pipe		α	LI		L2	
$\phi 1 \neq \phi 2$			90°	200	300	100
ø1 50x1,5	ø2 40x1,5					
ø1 60,3x1,5	ø2 45x1,5					
ø1 60,3x1,5	ø2 50x1,5					
ø1 65x1,5	ø2 50x1,5					
ø1 76,1x2	ø2 60,3x1,5					

02 BTEI

Tube/Pipe		α	LI		L2	
$\phi 1 = \phi 2$			90°	200	300	100
ø1 38,1x1,5	ø2 38,1x1,5					
ø1 40x1,5	ø2 40x1,5					
ø1 45x1,5	ø2 45x1,5					
ø1 50x1,5	ø2 50x1,5					
ø1 60,3x1,5	ø2 60,3x1,5					
ø1 65x1,5	ø2 65x1,5					
ø1 70x2	ø2 70x2					
ø1 76,1x2	ø2 76,1x2					
ø1 80x2	ø2 80x2					
ø1 84x2	ø2 84x2					
ø1 88,9x2	ø2 88,9x2					
ø1 101,6x2	ø2 101,6x2					
ø1 104x2	ø2 104x2					
ø1 114,3x2	ø2 114,3x2					

02 BREI

Tube/Pipe		LI	
ø1	ø2	150	200
ø 38x1,5	ø 40x1,5		
ø 38x1,5	ø 45x1,5		
ø 38x1,5	ø 54x1,5		
ø 40x1,5	ø 45x1,5		
ø 40x1,5	ø 50x1,5		
ø 40x1,5	ø 54x1,5		
ø 40x1,5	ø 60,3x1,5		
ø 44,5x1,5	ø 50x1,5		
ø 45x1,5	ø 54x1,5		
ø 45x1,5	ø 60,3x1,5		
ø 50x1,5	ø 54x1,5		
ø 50x1,5	ø 60,3x1,5		
ø 50x1,5	ø 65x1,5		
ø 50x1,5	ø 70x1,5		
ø 54x1,5	ø 70x1,5		
ø 60,3x1,5	ø 63,5x1,5		
ø 60,3x1,5	ø 65x1,5		
ø 60,3x1,5	ø 70x1,5		
ø 60,3x1,5	ø 76,1x1,5		
ø 60,3x1,5	ø 80x1,5		
ø 65x2	ø 70x2		
ø 65x2	ø 76,1x2		
ø 65x2	ø 80x2		
ø 65x2	ø 84x2		
ø 70x2	ø 76,1x2		
ø 70x2	ø 80x2		
ø 70x2	ø 84x2		
ø 70x2	ø 88,9x2		
ø 76,1x2	ø 63,5x2		
ø 76,1x2	ø 80x2		
ø 76,1x2	ø 84x2		
ø 76,1x2	ø 88,9x2		
ø 80x2	ø 84x2		
ø 80x2	ø 88,9x2		
ø 80x2	ø 100x2		
ø 84x2	ø 88,9x2		
ø 84x2	ø 101,6x2		
ø 84x2	ø 104x2		
ø 88,9x2	ø 101,6x2		
ø 88,9x2	ø 104x2		
ø 88,9x2	ø 108x2		
ø 101,6x2	ø 104x2		
ø 101,6x2	ø 108x2		
ø 101,6x2	ø 114,3x2		
ø 104x2	ø 108x2		
ø 104x2	ø 114,3x2		
ø 108x2	ø 114,3x2		

Disponible - Available





www.stifnet.com

EUROPE



STIF (Siège Social/Head Office) Usine / Factory

Z.A. de la Lande
49170 Saint-Georges-sur-Loire
FRANCE
Tél. : +33 2 41 72 16 82
Fax : +33 2 41 39 32 12
E mail : sales@stifnet.com
Web : www.stifnet.com

STIF IBERICA Bureau Commercial Sales Office

La Selva - 21 Nave 2
Pol. Indus. Les Salines
08880 Cubelles
BARCELONA - ESPAÑA
Tél. : +34 938 950 262
Fax : +34 938 950 298
E mail : ventas@stifiberica.es
Web : www.stifnet.com

STIF EASTERN EUROPE Bureau Commercial

Sales Office
Saltovskoe Hwy., 43,
Letter G-3, office 303
61038 KHARKOV
UKRAINE
E mail : stifee@stifnet.com
Web : www.stifnet.com

AMERICA

STIF AMERICA Bureau Commercial Sales Office

Oficina 4-04 – Centro Empresarial
Mar del Sur
Calle Primera El Carmen – Panamá
Rep. de PANAMÁ
Tél. : +507 393-3787
Fax : +507 393-7467
E mail : stifamerica@stifnet.com
Web : www.stifnet.com

ASIA

STIF (SUZHOU)

Usine / Factory
Unit 7, N°2318
East Taihu Lake Road
Wuzhong District, Suzhou City
Jiangsu Province, CHINA
Ph. : +86 512 6656 8968
Fax : +86 512 6656 9128
E mail : sales@stif.cn
Web : www.stif.cn

STIF ASIA Bureau Commercial Sales Office

2 Jurong East St 21
#04-28K IMM Building
SINGAPORE 609601
Ph. : +65 6563-2098
Fax : +65 6562-6083
E mail : sales@stif.com.sg
Web : www.stifnet.com

PT. STIF INDONESIA

Bureau Commercial
Sales Office
Jl. Ratna no. 1A
BEKASI – 17412
INDONESIA
Ph. : +62 21 8499 6745
Fax : +62 21 8499 5151
E mail : indo@stif.com.sg

